

Cosmopolitan Electrol

The Cosmopolitan® Electrol® is a ceiling or wall mounted electric screen. A variety of finishes and veneer options are available.

Features

- Decora-style, three-position wall switch
- Standard black backing retains projected brightness
- Seamless surfaces
- Optional floating mounting bracket allows screen to be mounted onto wall or ceiling studs and aligned left or right after installation (veneer can be added to bracket to match case)
- Available with built-in low voltage control, or Video Projector Interface (screen trigger) or silent motor or low voltage control with silent motor
- A ceiling trim kit is available that enables this screen to be easily recessed into a drop ceiling
- Standard white powder-coated finish; available in black upon request

Optional Accessories:

- Floating Mounting Bracket for Cosmopolitan and Tensioned Cosmopolitan Electrol
- Ceiling Trim Kit for Cosmopolitan Electrol
- Single Motor Low Voltage Control System
- Radio Frequency Wireless Remote Single Motor LVC
- Infrared Wireless Remote Single Motor LVC
- SCB-100
- Video Projector Interface
- Key Operated, 110 Volt Switch
- Locking Switch Cover Plate
- Dual Motor Low Voltage Control System
- Radio Frequency Wireless Remote - Dual Motor LVC
- Infrared Wireless Remote Dual Motor LVC



16:9 HDTV Format

Viewing Area (H x W)		Nominal Diagonal		Overall Case Length	
in.	cm	in.	cm	in.	cm
45" x 80"	114 x 203	92"	234	92"	234
52" x 92"	132 x 234	106"	269	104"	264
54" x 96"	137 x 244	110"	279	108"	274
58" x 104"	147 x 264	119"	302	116"	295
65" x 116"	165 x 295	133"	338	128"	325
78" x 139"	198 x 353	159"	404	152"	386

16:10 Wide Format

Viewing Area (H x W)		Nominal Diagonal		Overall Case Length	
in.	cm	in.	cm	in.	cm
50" x 80"	127 x 203	94"	239	92"	234
57½" x 92"	146 x 234	109"	277	104"	264
60" x 96"	152 x 244	113"	287	108"	274
65" x 104"	165 x 264	123"	312	116"	295
69" x 110"	175 x 279	130"	330	122"	310
72½" x 116"	184 x 295	137"	348	128"	325
87" x 139"	221 x 353	164"	417	152"	386

4:3 Video Format

Viewing Area (H x W)		Nominal Diagonal		Overall Case Length	
in.	cm	in.	cm	in.	cm
43" x 57"	109 x 145	72"	183	68"	173
50" x 67"	127 x 170	84"	213	78"	198
60" x 80"	152 x 203	100"	254	92"	234
69" x 92"	175 x 234	120"	305	104"	264
87" x 116"	221 x 295	150"	381	128"	325
105" x 140"	267 x 356	180"	457	152"	386

Square Format Dimensions

Sizes (H x W)		A - Overall Length of Case		B - Between Hanger Eyes		Approx. Ship. Wt.	
In.	Cm	In.	Cm	In.	Cm	Lbs.	Kg
60" x 60"	152 x 152	68"	172	66½"	169	38	17.2
70" x 70"	178 x 178	78"	198	76½"	194	41	18.6
84" x 84"	213 x 213	92"	234	90½"	230	49	22.2
8' x 8'	244 x 244	104"	264	102½"	260	55	25.0
9' x 9"	274 x 274	116"	295	114½"	291	62	28.1
10' x 10"	305 x 305	128"	325	126½"	321	78	35.4



Montaje en cielo raso

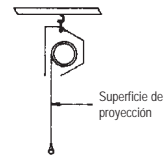

Oculto

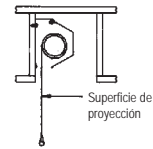

Vista izquierda

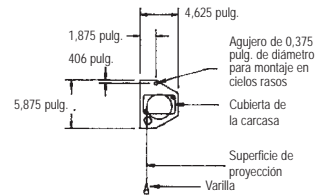

Montaje en pared



Utilice soportes No. 6 para colgar la pantalla detrás de una viga o dosel

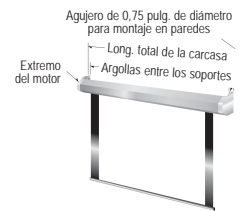
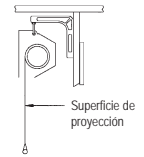

Available with the Following Screen Surfaces



Matte White

Half Angle: 60° Gain: 1.0

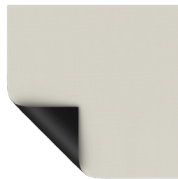

High Contrast Matte White

Half Angle: 50° Gain: 1.1



Video Spectra 1.5

Half Angle: 35° Gain: 1.5

Product images

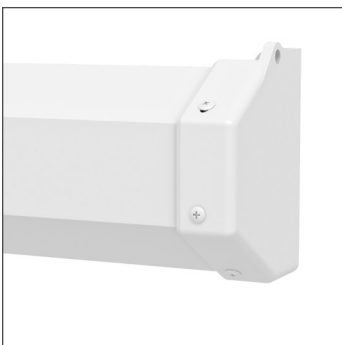

White Case (Standard)

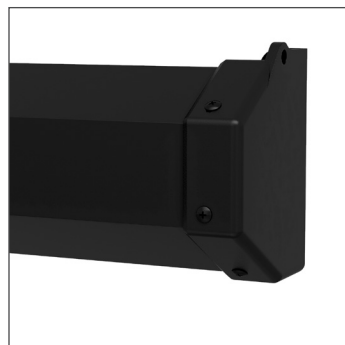

Black Case



A BRAND OF MILESTONE AV TECHNOLOGIES | www.milestone.com

P 800.622.3737 / 574.267.8101 **F** 877.325.4832 / 574.267.7804

E info@da-lite.com

In British Columbia, Milestone AV Technologies ULC carries on business as MAVT Milestone AV Technologies ULC.

©2018 Milestone AV Technologies. DL-0444 (Rev. 4) 0418.

Da-Lite is a registered trademarks of Milestone AV Technologies. All other brand names or marks are used for identification purposes and are trademarks of their respective owners. All patents are protected under existing designations. Other patents pending.